

CÓMO CREAR CORRECTAMENTE UN ARCHIVO PARA LA IMPRESIÓN DE LETRAS DE CARTÓN

Las siguientes indicaciones te ayudarán a crear un archivo de impresión correcto. Si todavía tienes dudas, puedes consultar la sección FAQ de nuestro sitio web, activar la opción de Control del archivo por un gráfico o llamar a nuestro servicio de Asistencia.

Con este producto se pueden imprimir letras de cartón en color habano (sin impresión) o impresas en cuatricromía sobre fondo de color habano (impresión sólo en el frente).

1 ORIENTACIÓN

La opción «Orientación» se refiere al sentido de lectura de los caracteres. En el caso de orientación horizontal, será de izquierda a derecha; en el caso de orientación vertical, será de arriba abajo.

Según la orientación seleccionada, se te dará una plantilla para colocar con facilidad las letras sobre una superficie.

2 SET DE CARACTERES

Las letras son creadas en la fuente **Helvetica Neue LT Std Black**. Aquí abajo encontrarás el set de caracteres disponibles.

ABCDEFGHIJKLMNOPQRSTUVWXYZ
abcdefghijklmnopqrstuvwxyz
0123456789 !?%&@€\$£

OPCIÓN «SIN IMPRESIÓN»

Añade en «Campo de texto» la frase o la secuencia de letras que quieres pedir y selecciona la orientación.



OPCIÓN «IMPRESIÓN SÓLO FRENTE»

Añade en «Campo de texto» la frase o la secuencia de letras que quieres pedir y selecciona la orientación.

Las letras de cartón sólo se pueden imprimir por un lado, con un diseño continuo que puedes crear siguiendo las indicaciones que encontrarás a continuación.



3 FORMATO DEL ARCHIVO

Envía tu archivo en formato **PDF en escala 1:1 (sin protección de contraseña)**.

4 COLORES

Ten en cuenta que, en el producto impreso, **los colores se verán más oscuros, ya que el soporte sobre el que se imprime es de color habano**, no blanco. Además, los elementos que ves en blanco en tu archivo quedarán transparentes en el producto impreso. Todos los archivos se envían en **CMYK** (cian, magenta, amarillo, negro) asignando el **perfil color Fogra 39**. Las imágenes en RGB o con colores PANTONE serán convertidas a un perfil de separación estándar de forma automática.

5 RESOLUCIÓN

La resolución óptima de los archivos para la impresión es **de 100 a 150 dpi**.

6 INFORMACIÓN ADICIONAL

El trazo mínimo de impresión es de 0,5 pt.

8 PATRÓN PERSONALIZADO

El patrón personalizado deberá medir 35 x 35 cm en el caso de letras con altura media de 25 cm, y 70 x 70 cm en el caso de letras con altura media de 50 cm.

Descarga del sitio web **la plantilla** y úsala como base para colocar tu diseño. Verás ya correctamente establecidas las dimensiones del diseño. **Es fundamental que los elementos gráficos que componen tu diseño estén colocados de modo que se pueda repetir en secuencia sin interrupciones.** Para terminar, guarda el archivo en pdf sin añadir sangrado, marcas de guía o marcas de corte.

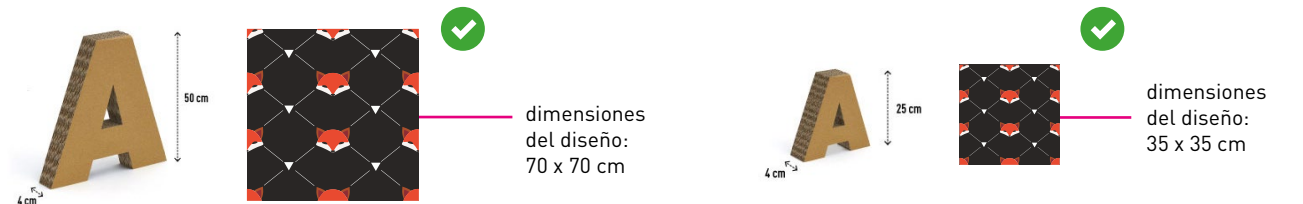

Diagram illustrating the correct and incorrect ways to place a pattern for a letter 'A' with a height of 50 cm and a thickness of 4 cm.

Top Left: A 3D model of a letter 'A' with a height of 50 cm and a thickness of 4 cm. Next to it is a 70 x 70 cm pattern of fox heads. A green checkmark is next to it. Text: "dimensiones del diseño: 70 x 70 cm".

Top Right: A 3D model of a letter 'A' with a height of 25 cm and a thickness of 4 cm. Next to it is a 35 x 35 cm pattern of fox heads. A green checkmark is next to it. Text: "dimensiones del diseño: 35 x 35 cm".

Bottom Left: A horizontal strip of the 70 x 70 cm pattern. A green checkmark is above it. A pink circle highlights a fox head. Text: "los elementos del diseño se repiten sin interrupciones".

Bottom Right: A horizontal strip of the 70 x 70 cm pattern. A red 'X' is above it. A pink circle highlights a fox head. Text: "los elementos del diseño se repiten creando interrupciones".

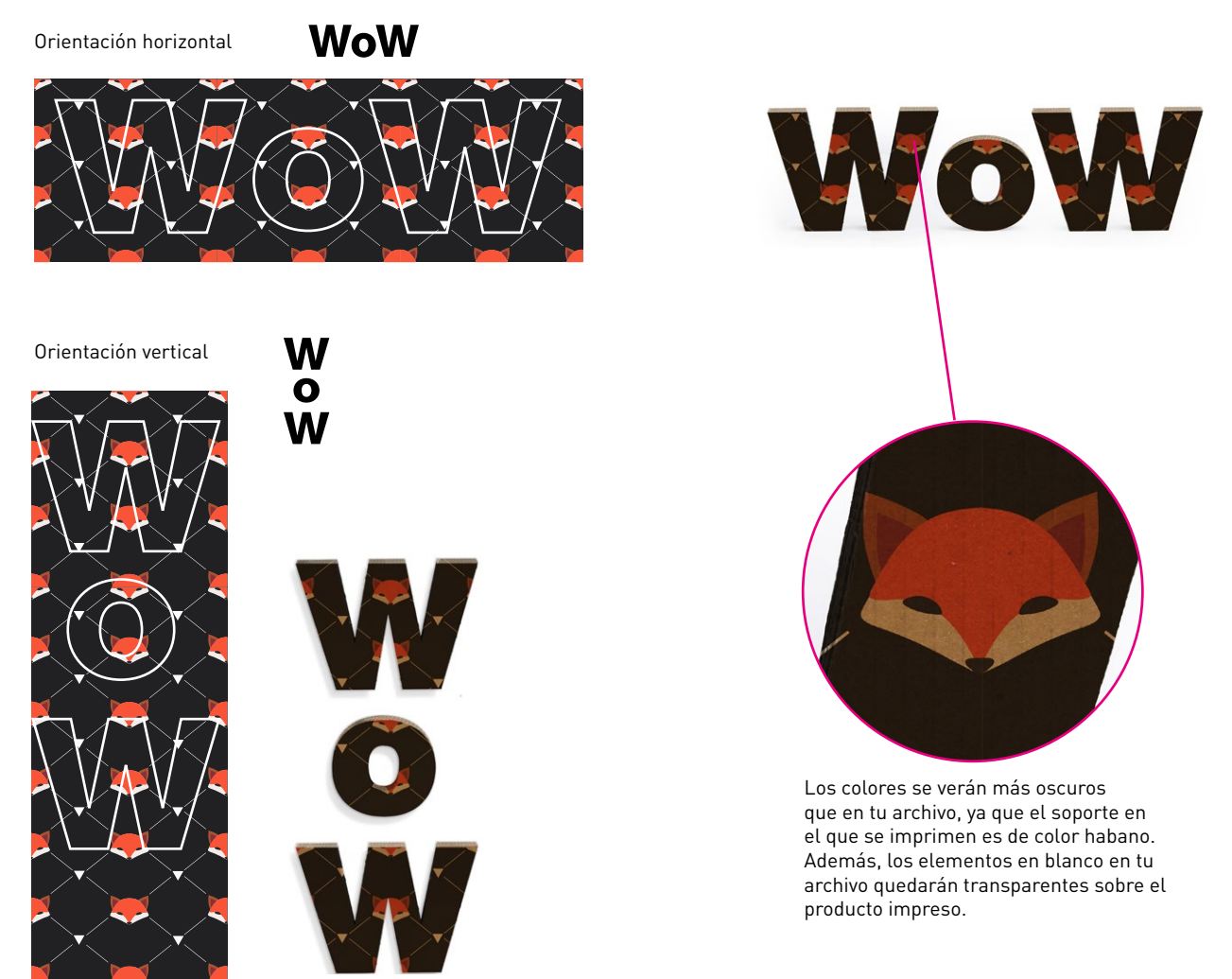

Diagram illustrating the horizontal and vertical orientations for the word "WoW" and a close-up of the fox head pattern.

Horizontal Orientation: The word "WoW" is shown in a white outline font on a background of the fox head pattern. A 3D model of the word "WoW" is shown to the right, with a pink circle highlighting a fox head on the letter 'o'. Text: "Orientación horizontal WoW".

Vertical Orientation: The word "WoW" is shown in a white outline font on a background of the fox head pattern. A 3D model of the word "WoW" is shown to the right. Text: "Orientación vertical WoW".

Close-up: A circular inset shows a close-up of the fox head pattern. Text: "Los colores se verán más oscuros que en tu archivo, ya que el soporte en el que se imprimen es de color habano. Además, los elementos en blanco en tu archivo quedarán transparentes sobre el producto impreso."

ATENCIÓN: Letras de cartón impresas

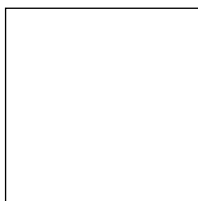

DESCARGA
LA PLANTILLA

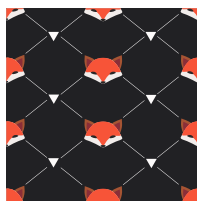

INSERTA
TU DISEÑO



GUARDA
EL PDF



PDF



100-150 dpi



CMYK



FOGRA 39



sangrado



marcas de corte

LETRAS de 25 cm de alto

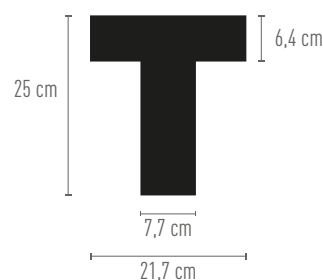
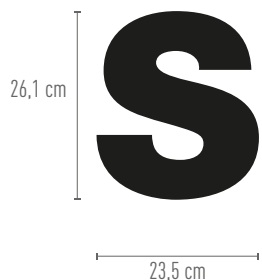
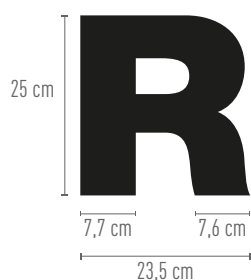
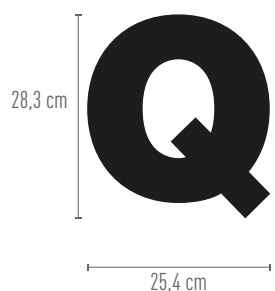
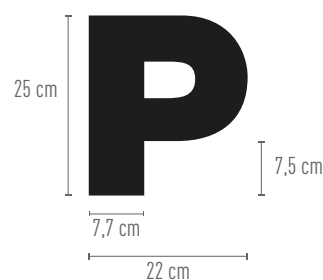
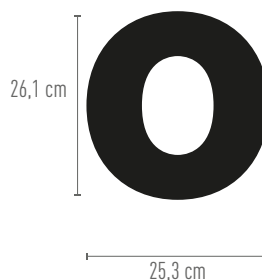
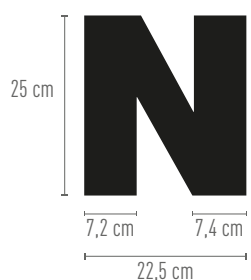
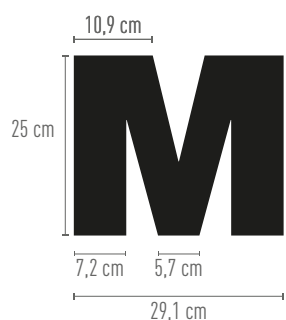
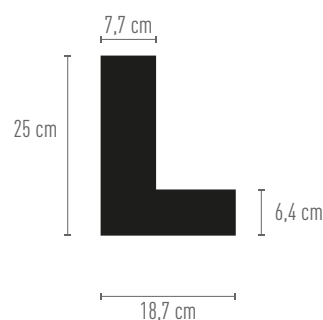
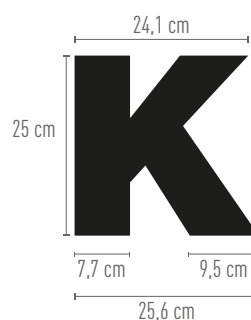
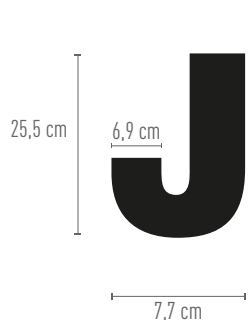
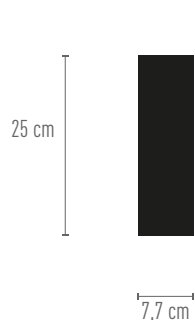
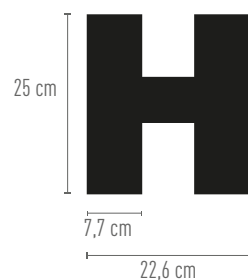
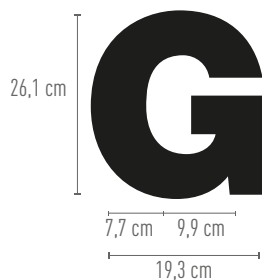
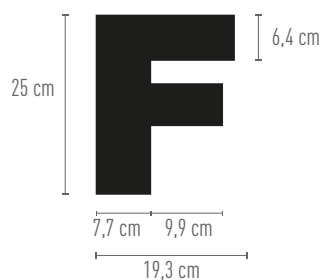
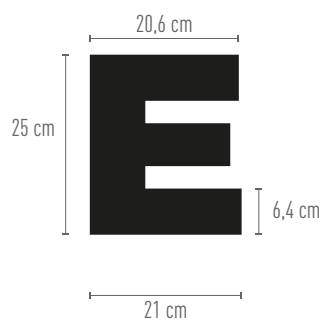
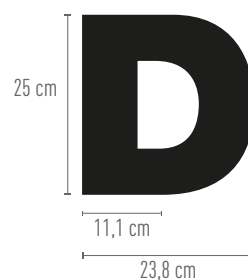
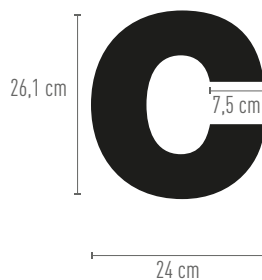
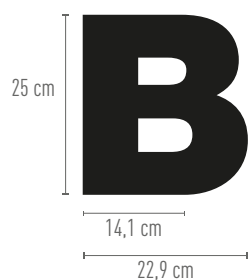
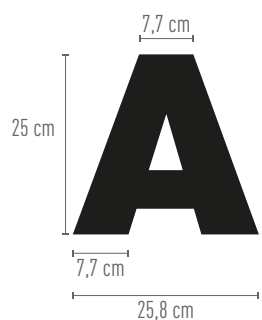

LETRAS de 25 cm de alto

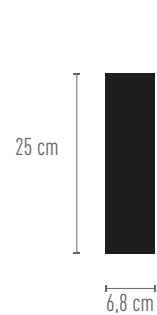
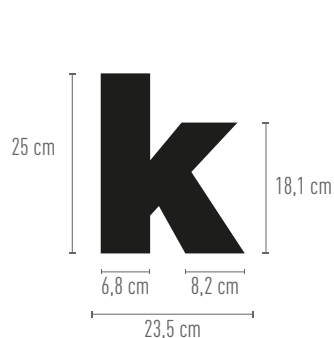
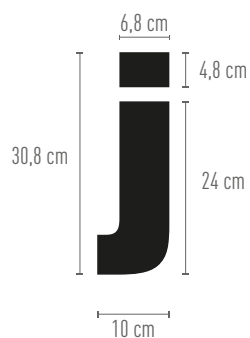
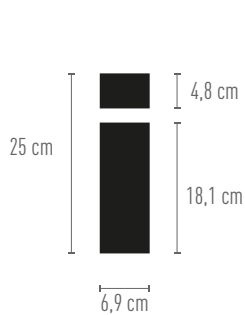
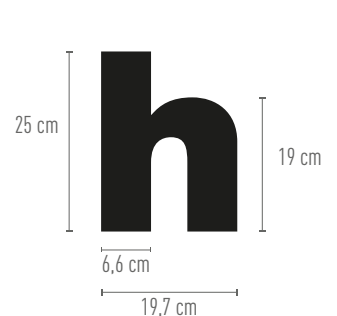
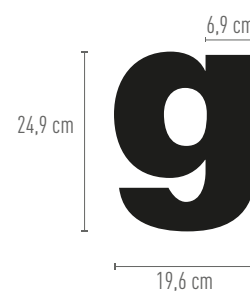
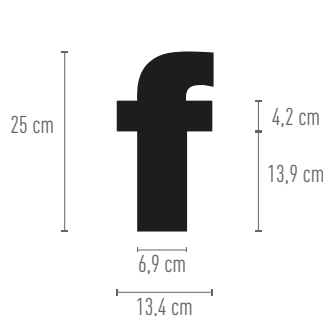
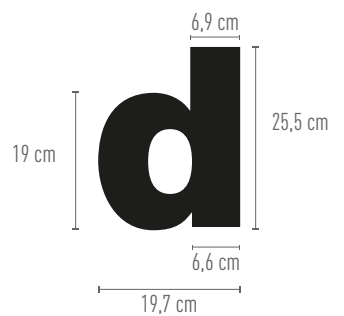
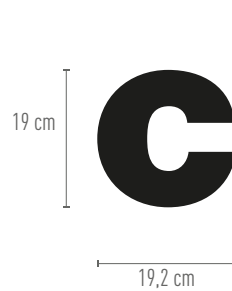
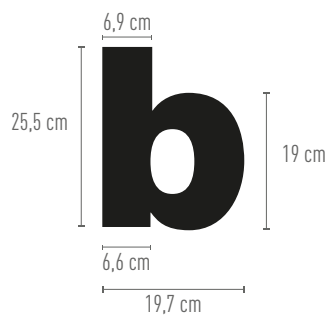
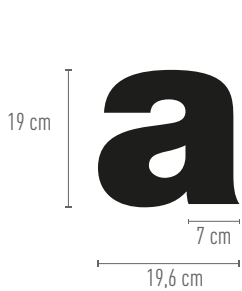
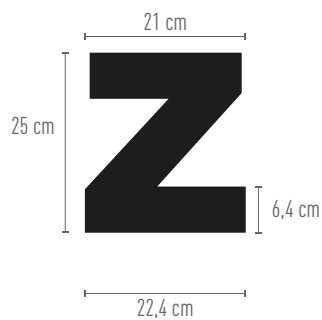
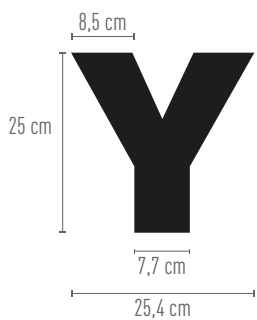
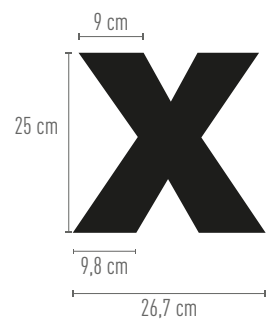
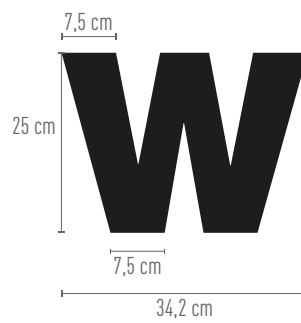
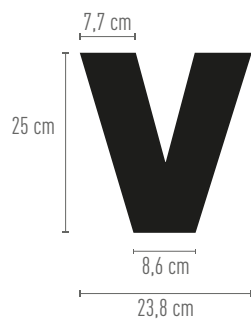

LETRAS de 25 cm de alto

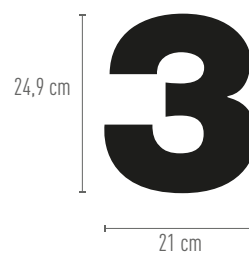
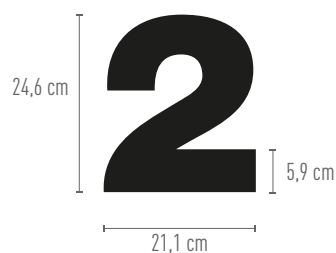
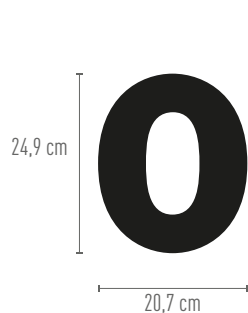
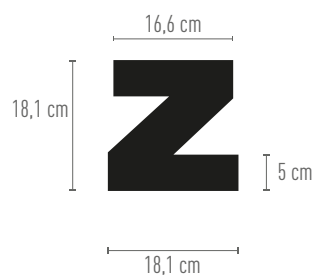
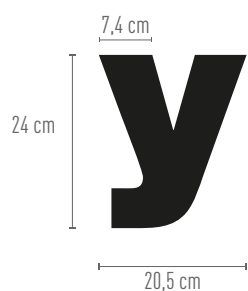
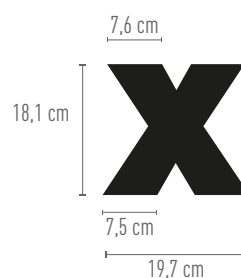
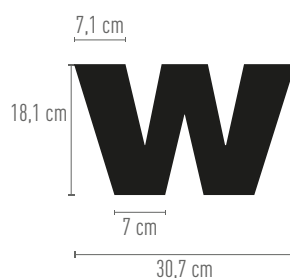
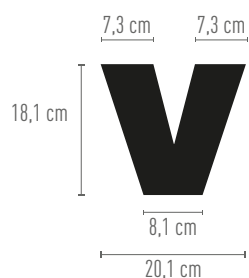
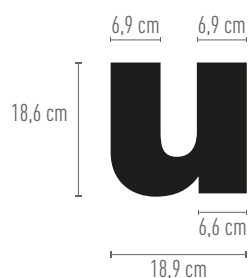
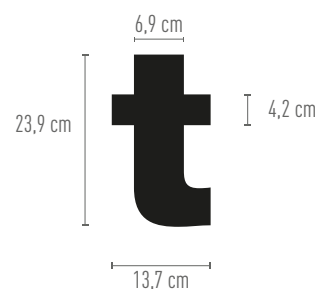
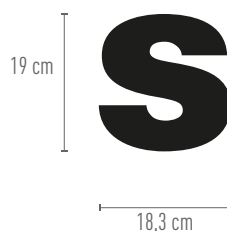
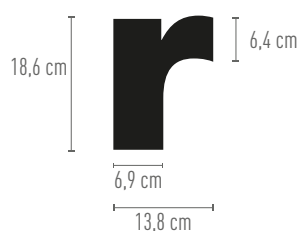
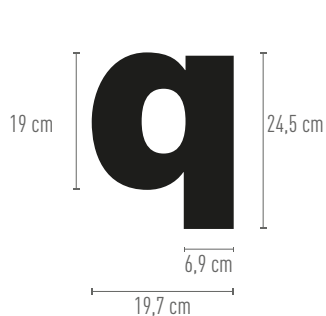
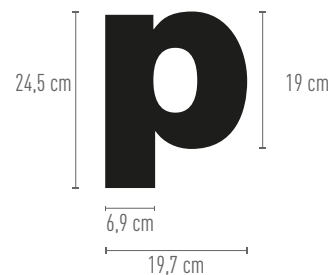
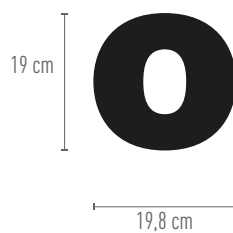
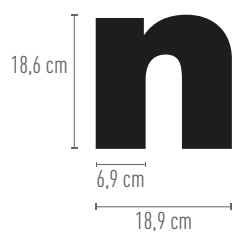
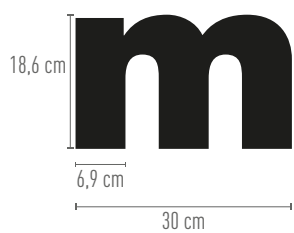

LETRAS de 25 cm de alto

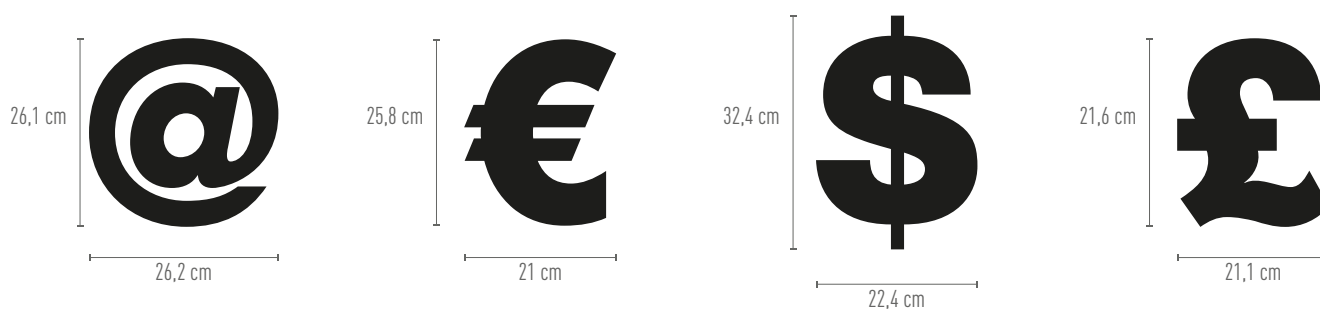
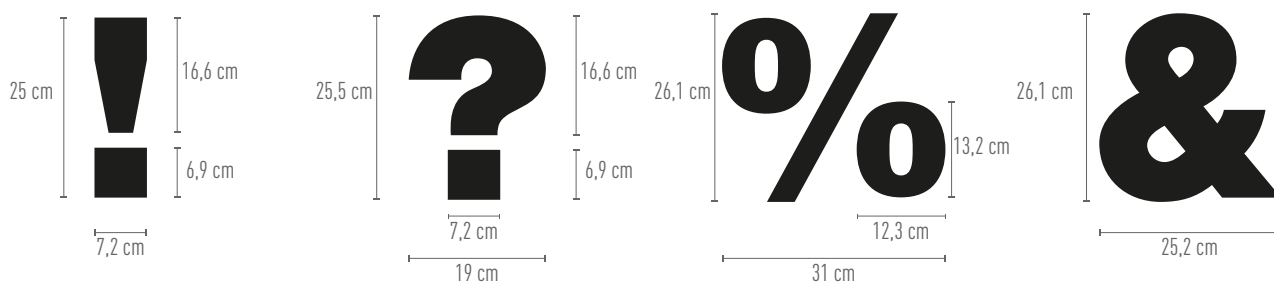
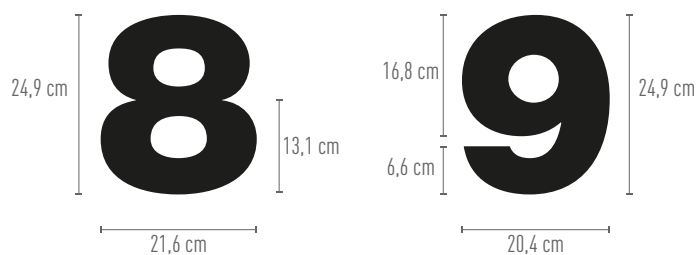
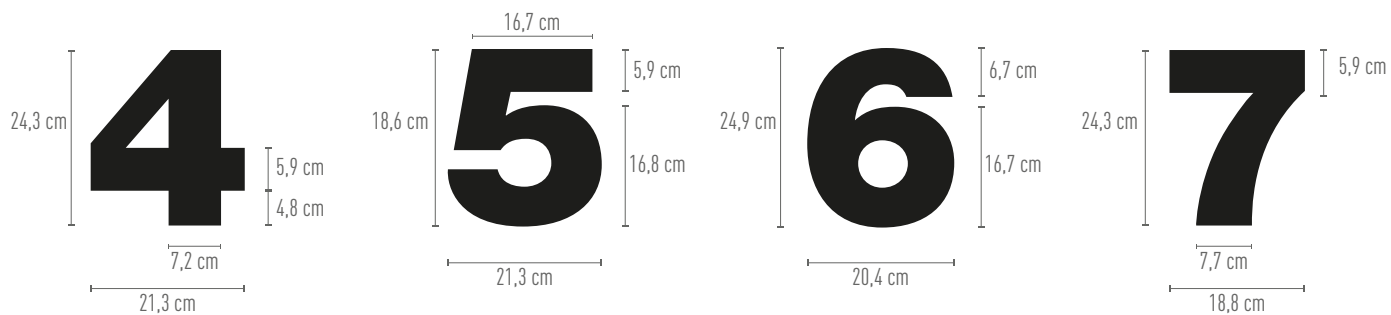

LETRAS de 50 cm de alto

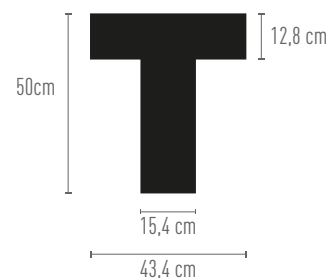
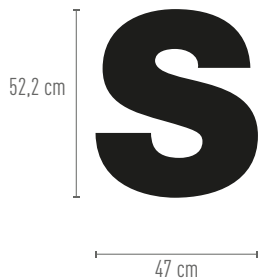
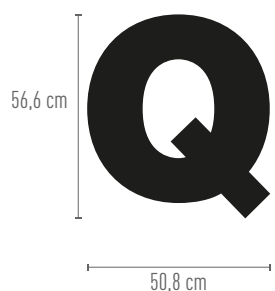
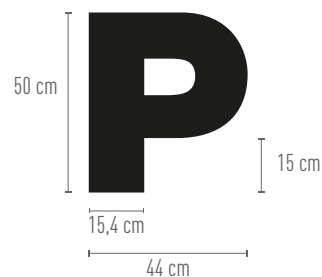
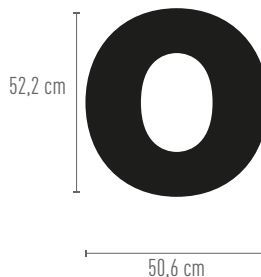
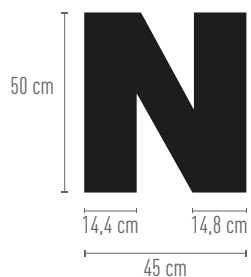
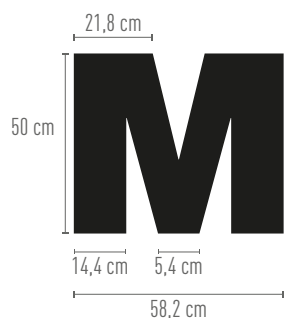
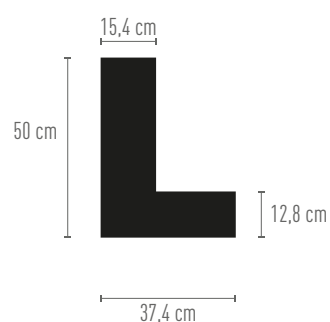
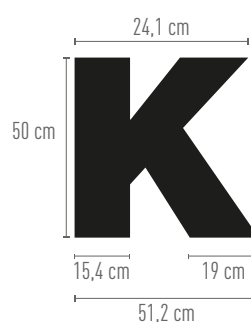
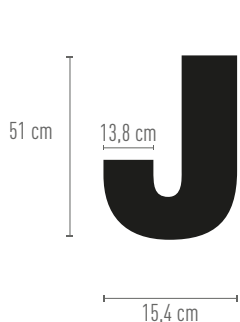
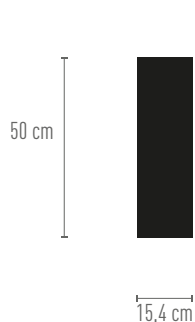
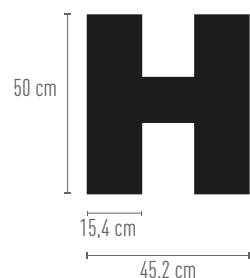
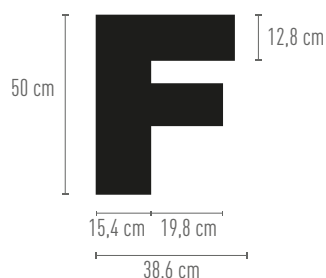
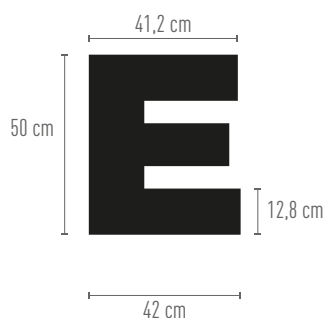
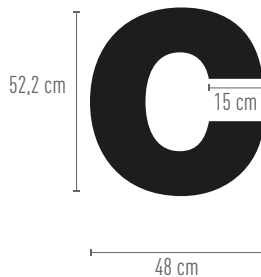
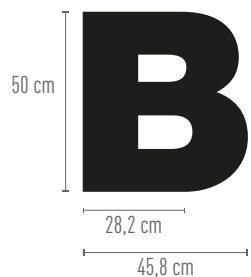
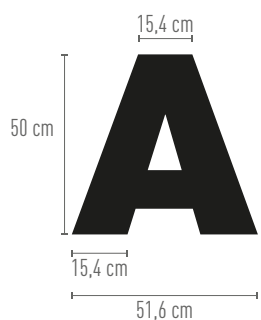

LETRAS de 50 cm de alto

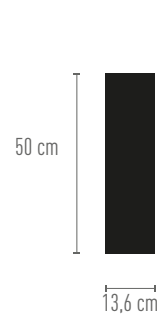
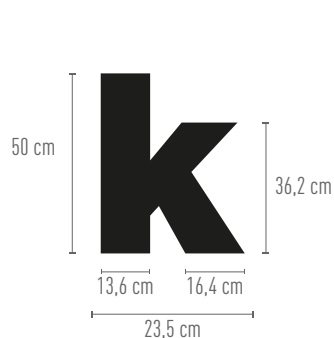
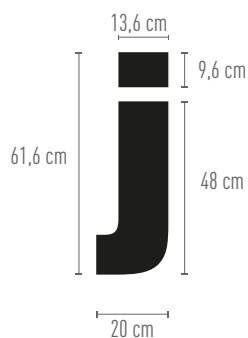
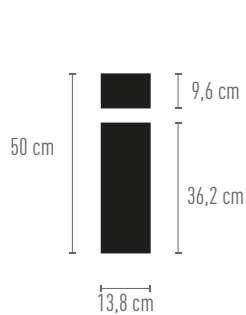
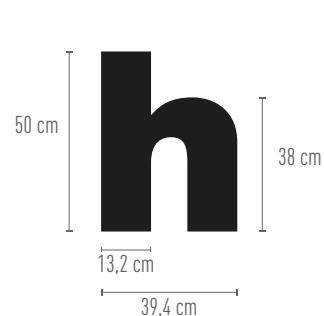
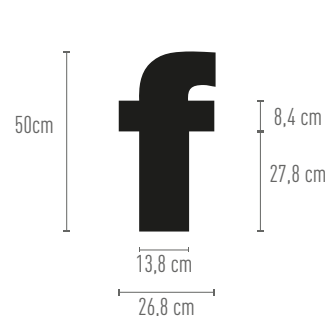
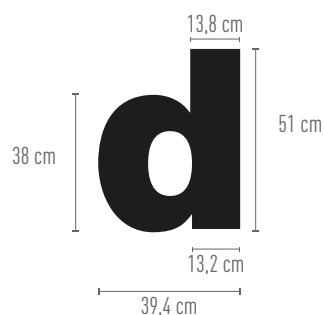
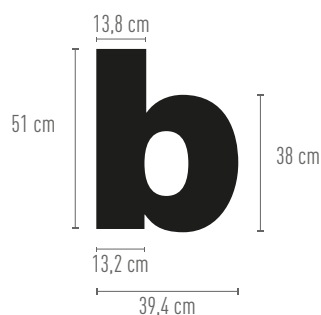
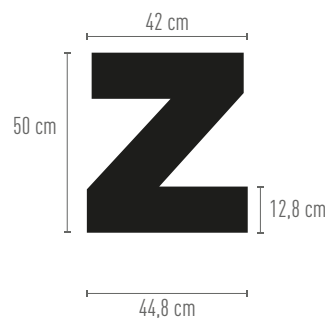
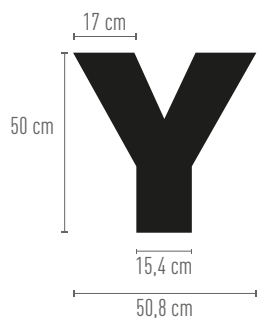
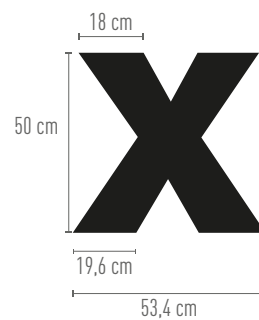
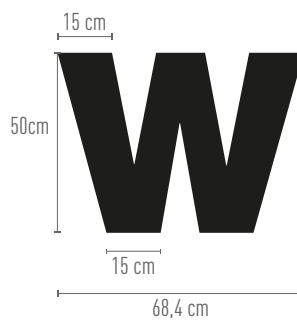
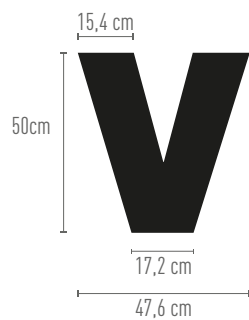
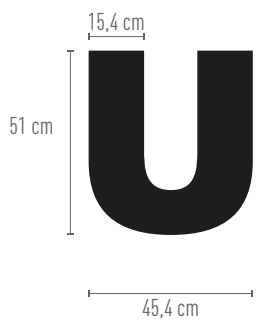

LETRAS de 50 cm de alto

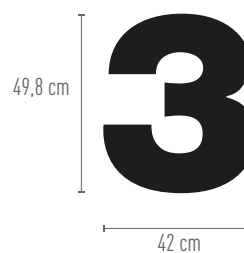
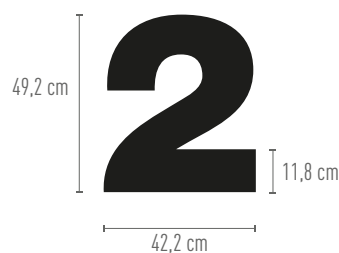
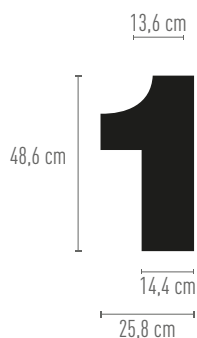
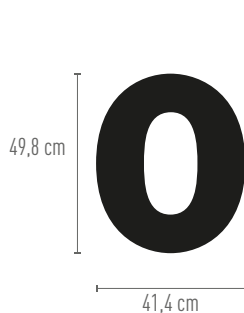
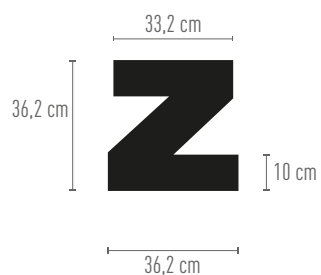
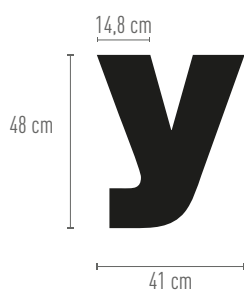
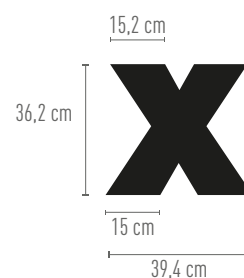
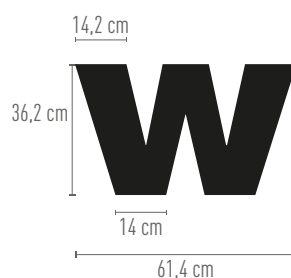
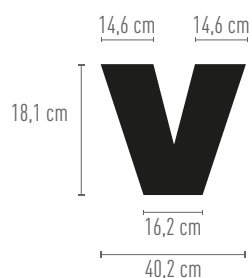
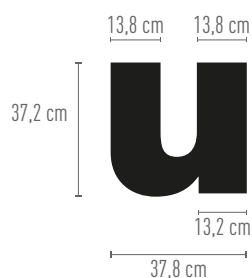
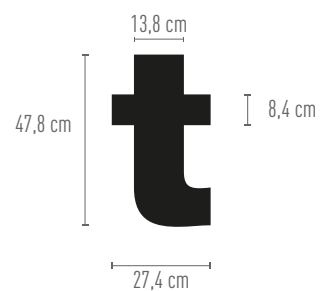
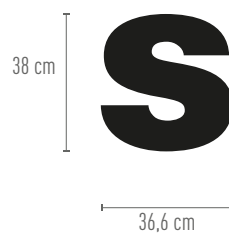
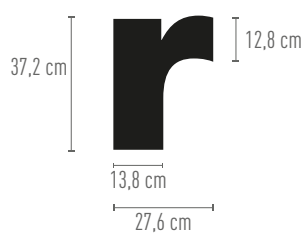
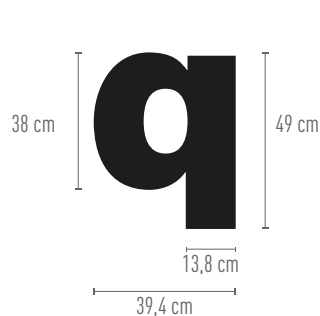
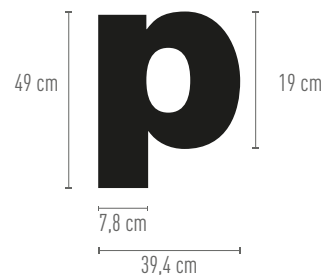
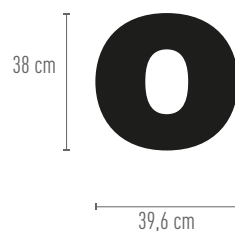
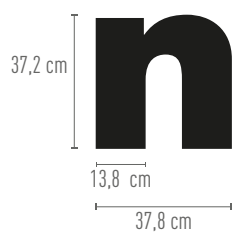
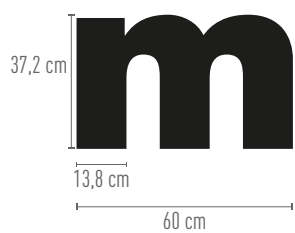

LETRAS de 50 cm de alto

